

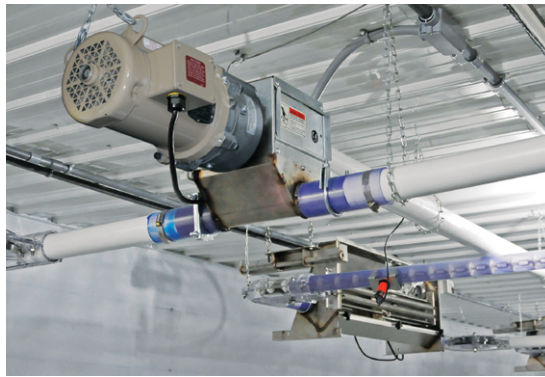

DEPENDABLE AUTOMATED OPERATION
CHAIN DISK FEED DELIVERY

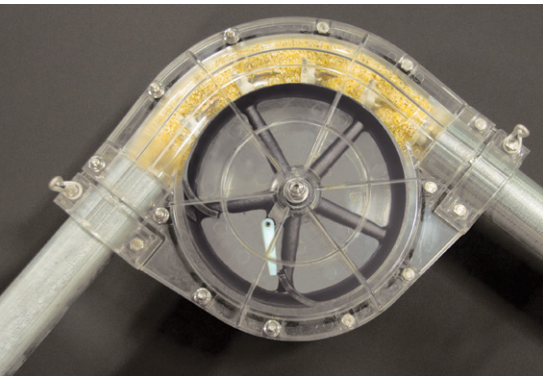

Adapt and Overcome

Chain Disk feed delivery systems have the flexibility to adapt to all types of swine production facilities and the ability to overcome the performance and reliability constraints of other systems. Chain Disk is ideally suited to delivering feed to multiple farrowing rooms, individual sow stalls, electronic sow feed systems and the high volume demands of large finishing facilities. The gentle conveying method limits damage to expensive pelleted rations and prevents particle separation in ground feed rations. Chain Disk's rugged design, quality components and unique control system enable it to outperform the competition in capacity, distance and durability.

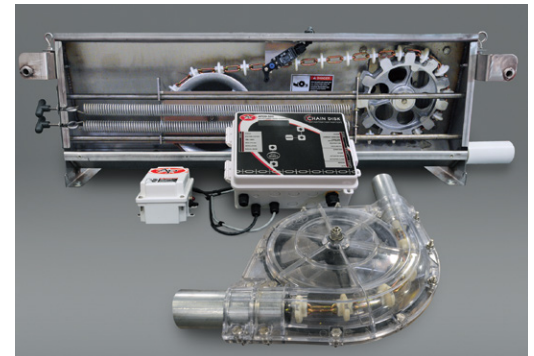

HEAVY-DUTY DRIVE UNITS

Chain Disk drive units are constructed of corrosion resistant 304 stainless steel and feature heavy duty, high efficiency, helical bevel gearboxes. High efficiency means more torque with less horsepower decreasing operating cost without sacrificing performance. Explosion proof motors are also available to fit those applications with such a requirement.

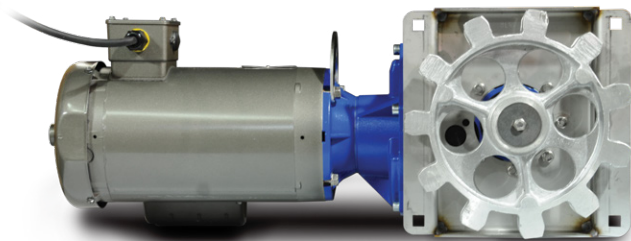
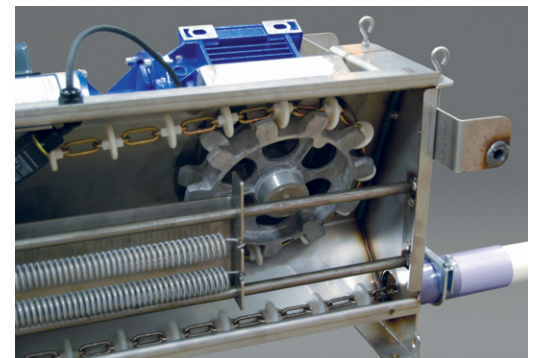

CLEAR CORNER HOUSING

Clear corner housings provide visual confirmation the system is operating properly at all times. The patented* pivoting wiper ensures that feed does not accumulate in the center of the corner housing. Special corner units are available for inclined or vertical installation.

*U.S. Patents 8,418,837 and 8,245,837. Canada Patent CA 2690694C.



QUALITY CHAIN

Durable, low friction nylon disks injection molded onto hardened steel chain provide years of trouble free service eliminating the maintenance and down time associated with cable style conveyors.



Chain Disk drive units feature an automatic chain tensioning system to reduce maintenance and a safety shut off switch to shut down the system if it becomes plugged by a foreign object.



CHAIN DISK TUBING

Chain Disk is available with three styles of conveyor tubes to meet the requirements of every application.

- PVC Tube – Corrosion free and quick and easy to install, ideal for farrowing and other low volume applications
- Welded Steel Tube – Ideal for high volume applications like finishing and electronic sow feeding
- Welded Steel Tube w/ Pre-Cut Holes – High volume performance with the added convenience of pre-cut holes to reduce installation time. Hole spacing is available in 18", 19", 20", 22", 23" and 24".

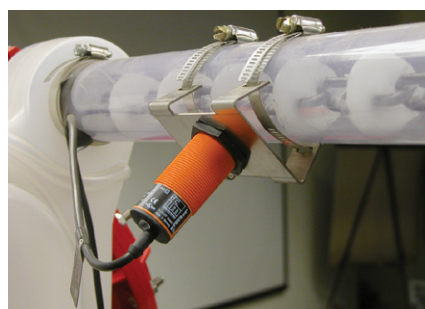

TUBE SENSOR

A tube mounted sensor will shut down the system when feed returns to the inlet hopper indicating that all feeders have been filled. Chain Disk's sensor design eliminates the challenges caused by empty farrowing or nursery rooms and eliminates the task of maneuvering sows in your breeding and gestation facilities to keep the feed system operating correctly.

CHAIN DISK CONTROLLER

The Chain Disk Controller enables the feeding system to be programmed to operate how and when you want and constantly monitors the system to insure proper operation. Drive unit motor current is constantly monitored to ensure that the system is not over loaded. When amp draw spikes, the Flex-Flo fill system is temporarily shut down by the controller until the drive unit motor amp draw decreases and normal operation resumes. A programmable maximum run timer will shut down the Chain Disk and the Flex-Flo systems if the system runs continuously for an excessive amount of time indicating that a bin is empty or a costly feed spill is occurring.



Available in two models:

The APCD-500 features a 24 hour time clock and actuator outputs making it ideal for automated feeding in breeding and farrowing facilities.

The APCD-600 features continuous feeding making it the ideal controller for nurseries and finishing.

CHAIN DISK SPECIFICATIONS

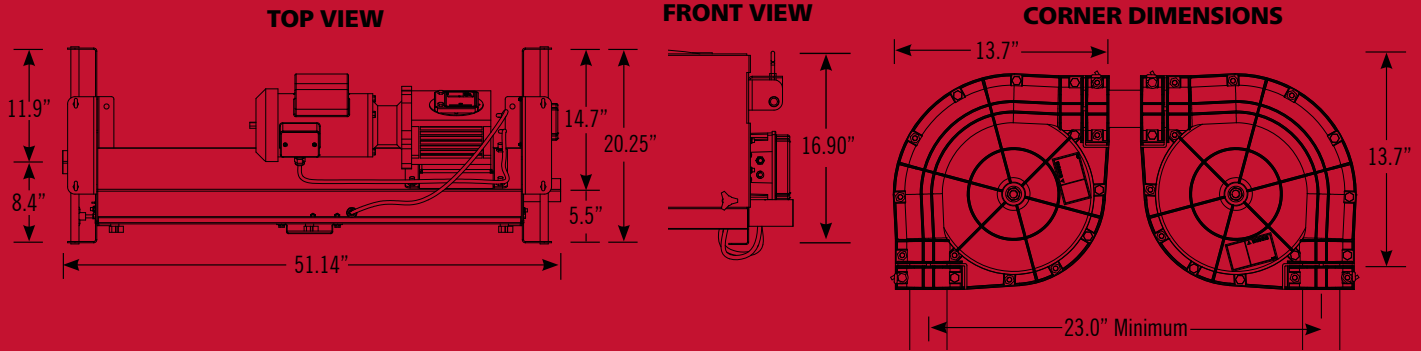

CHAIN DISK TUBING

CHAIN DISK TUBE	RECOMMENDED APPLICATIONS	CHAIN DISK MUST NOT EXCEED ANY OF THESE 3 DESIGN CRITERIA				FLEX-FLO FILL SYSTEM	EFFECTIVE LENGTH	EFFECTIVE CAPACITY***
		MAX. CORNERS	MAX. CHAIN	MAX. EFFECTIVE LENGTH*	MAX. DAILY RUN TIME**			
2.36" OD PVC Tube	Farrowing/Lactation	24 Corners	1,150 Feet	1,750 Effective Feet	100 Minutes per Day	Model 300 @ 250 RPM (35 lbs. per minute)	Up to 1,000	35
	Nursery						1,000 - 1,250	30
							1,250 - 1,500	25
							1,500 - 1,750	20
2.36" OD Welded Steel Tube	Breeding and Gestation with Electronic Sow Feeding (ESF)	24 Corners	1,900 Feet	2,000 Effective Feet	240 Minutes per Day	Model 300 @ 250 RPM (35 lbs. per minute)	Up to 1,500	35
							1,500 - 1,750	30
							1,750 - 2,000	25
	Farrowing/Lactation	24 Corners	1,900 Feet	2,000 Effective Feet	240 Minutes per Day	Model 300 @ 358 RPM (50 lbs. per minute)	Up to 1,000	50
							1,000 - 1,250	45
							1,250 - 1,500	40
							1,500 - 1,750	35
Finishing	1,750 - 2,000	30						

Chain Disk Systems are designed to convey mashed, crumbled or pelleted feeds not to exceed 18% moisture content.

*Effective length of a Chain Disk system = Total feed of Chain Disk chain + (number of Chain Disk corners x 25)
 Example - Seven-hundred feed of Chain Disk tubing + (Sixteen Chain-Disk corners x twenty-five) = 1,100 Effective ft.

**Daily Run Time of a Chain Disk system = Maximum daily feed requirement divided by "Effective Capacity"
 Example - Eight-hundred gestatin sows x five pounds per sow per day (4,000 lbs) / 20 pounds per minute "Effective Capacity" = 200 Minutes

***Lbs. per minute based on 40 lbs. per cu ft. Effective Capacity of a Chain Disk system is the estimated actual fill rate of the system when adjusted for the cycling of the Flex-Flo fill system by the Chain Disk controller's current sensor to prevent system overload.

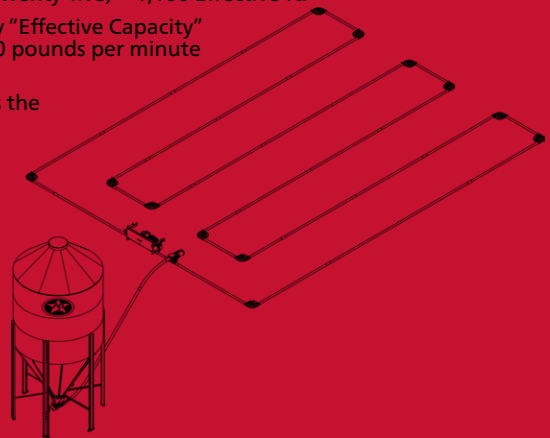

AP's Flex-Flo™ flexible auger feed delivery system delivers a continuously metered flow of feed from the bin to the Chain Disk system.



AUTOMATED PRODUCTION SYSTEMS
 1004 E. Illinois St. Assumption, IL 62510 USA
 Tel: 217-226-4449 Fax: 217-226-3540
 Int'l Tel: 217-226-4401
 Tech Support: 712-239-1011



For more information on AP's many products and services, contact your local AP representative or visit us online at:
www.automatedproduction.com