

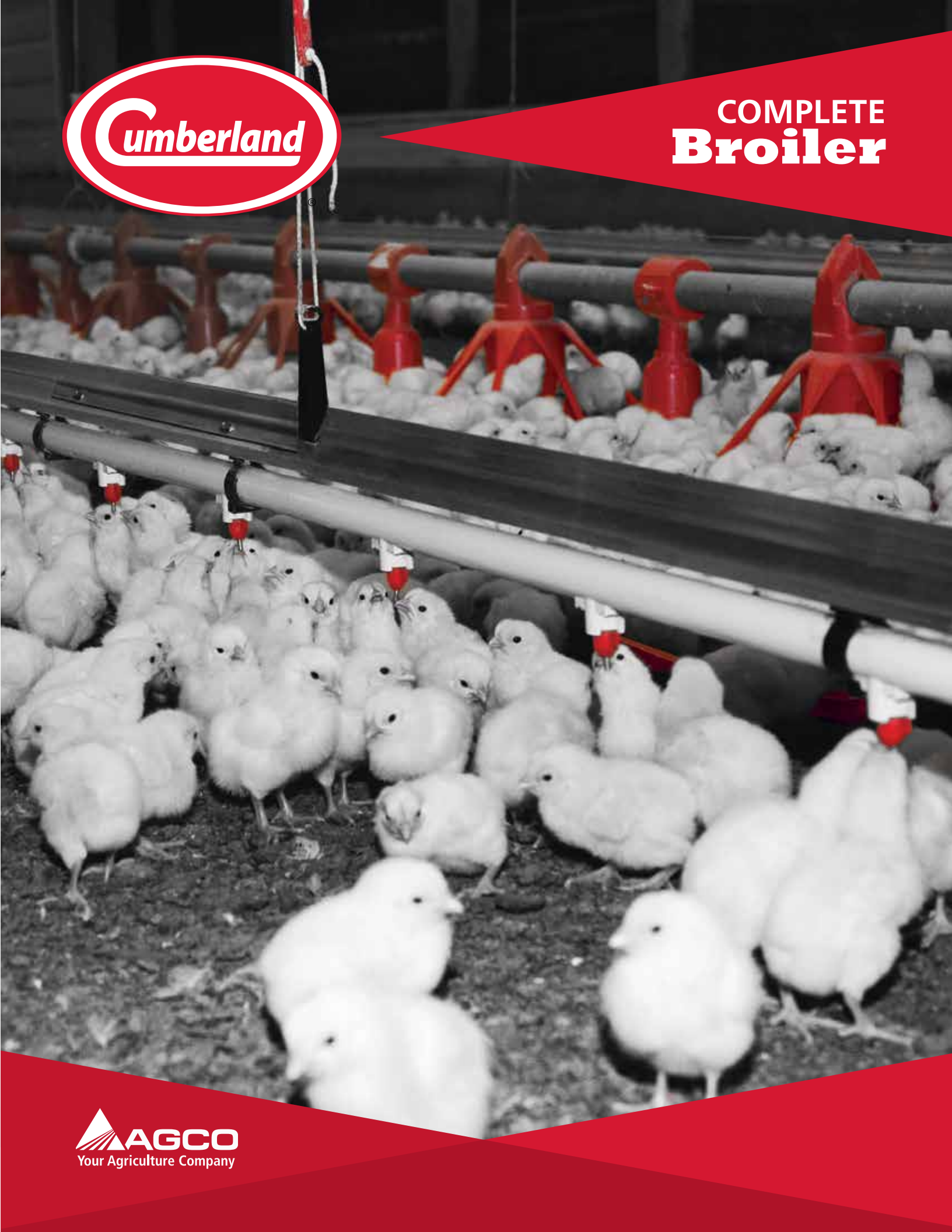

COMPLETE
Broiler



Pan Feeding

Cumberland manufactures a variety of broiler pan feeder models to accommodate the specific needs of each and every grower. All of our broiler pan feeders represent a concept for taking birds from day old through adult. We can help build a system that provides the performance you need to maximize the return on your investment.



HI-LO™ CLASSIC



HI-LO™ VIII



PRO-1

* US Patent No. 7,647,888



PRO-1 RETRO-KIT



HI-LO FEED LEVEL & FEED LEVEL STAND

Hi-Lo™ Feeder

Take birds through all stages of growth with the Hi-Lo Classic or Hi-Lo VIII pan feeders.

- Multiple levels of feed depth control
- 2" to 3.5" collapsible/expandable pan accommodates bird size
- 8 or 14 spoke pan design
- 360° pan play reduces bruising and injury
- Exclusive feed saving design features
- Optional 2-piece drop tube



The Hi-Lo™ telescoping drop tube automatically compensates for uneven floor conditions. The drop tube is available in either the standard one piece or optional two piece design.



Pro-1™ Feeder

Customize the Pro-1 to your bird size and feeding requirements.

- Flood feeding windows
- Optional 2" to 3.5" collapsible/expandable pan accommodates bird size
- First in/first out feed level settings
- 8 spoke design for easy bird access
- Clear guard keeps chicks from entering the flood window
- Optional 2-piece drop tube

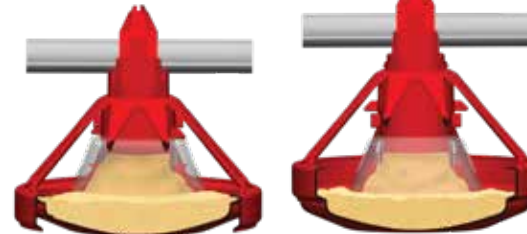

2" COLLAPSED POSITION

3.5" LOCKED POSITION



Collapsed Flood Position with Window Guard



Locked Flood Position with Window Guard

Turn any existing Hi-Lo feeder into a Pro-1 Broiler Pan Feeder with the Pro-1 Retro-Kit.



RELIABLE FEEDING
Performance



Flood Feeding with Options

Cumberland's E-Feeder and NutraPan flood feeders can easily be adjusted to fit your particular feed level requirements. Simple to install with plenty of customizable options make these feeders a flexible choice for flood feeding.



E-Feeder™

The all-plastic E-feeder is a dependable flood feeder designed for long life and dependable flood feeding. It features a 14-spoke design for bird separation, adjustable feed depth levels and flood feeding windows.

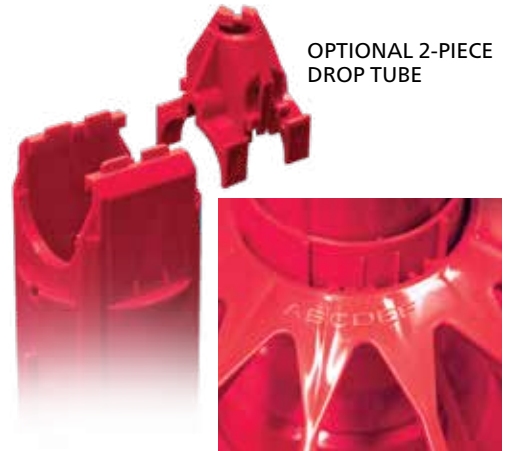

OPTIONAL 2-PIECE DROP TUBE

ADJUSTABLE FEED DEPTH LEVELS



NutraPan™

The NutraPan no spoke design provides uninhibited access to the pan. A clear guard keeps chicks from entering the flood window. Six levels of feed depth control with easy twist lock adjustment. Other features include a 3.5" pan depth and 2-piece drop tube for easy assembly.



Micro Switch Control Pan

All single phase motors feature an industry proven centrifugal actuator design. Bleed resistors have been added to all motors with capacitors to reduce heat buildup for frequent start applications. Cumberland 50/60 Hz feeding motors come with a two year warranty.

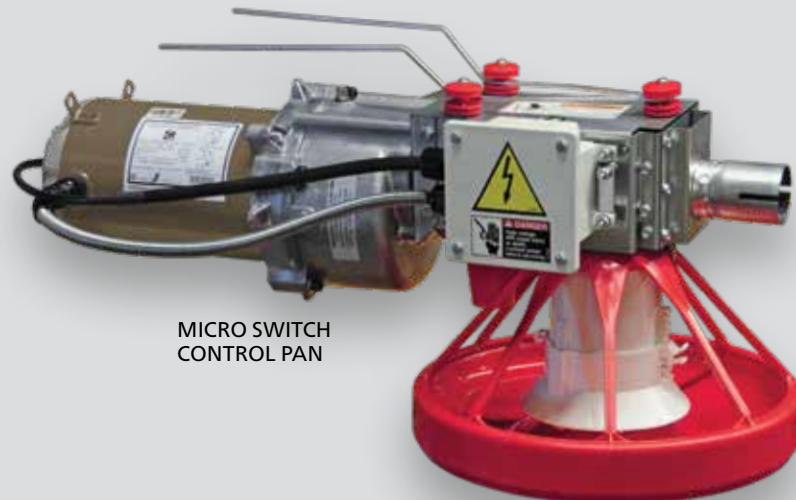

MICRO SWITCH CONTROL PAN

A durable plastic overflow bypass funnel conveniently redirects any feed that may have escaped falling through the control pan drop tube back into the feed pan.



Hi-Lo™ and E-Feeder™ I-Plus3 Bolt-on Center-house control pans offer all the features of our i-plus3 control pan line with the added convenience of being a bolt-on model for retrofit installations.



i-plus3

control pan

The i-plus3 control pan line utilizes infrared technology to sense and detect the level of feed in the control pan for proper and reliable operation, day in and day out.

- Reliable feed sensing technology that promotes full pans and healthy birds to maximize feed conversions
- Easy to use with no moving parts or sensitivity adjustments
- Power supply is included in the i-plus3 control pan for an optional LED light

US Patent No. 8,915,214



Intertek

Certification applies to controls



As the i-plus3 Control Pan fills, the infrared beams detect the feed level.



When the feed level breaks all three of the infrared sensors, the auger will stop automatically.



When the feed drops below the infrared sensors, the auger will re-start automatically after a 60 second delay.



Hi-Lo Control Pan LED Light

An optional Hi-Lo control pan LED light is available to stimulate bird activity to the feed line control pan. Where other systems utilize a directional light source mounted outside the control pan, Cumberland's light assembly attaches directly above the feed pan providing 360° of lighting coverage.

- Easily retrofitted to existing Cumberland Hi-Lo control pans in the field
- Kit is factory assembled for ease of field installation
- Control pan light can be operated on 115VAC or 230VAC
- Substantial energy savings per year when compared to a standard 60 watt bulb
- The control pan LED light plugs directly into the power supply included in the i-plus3 control pan

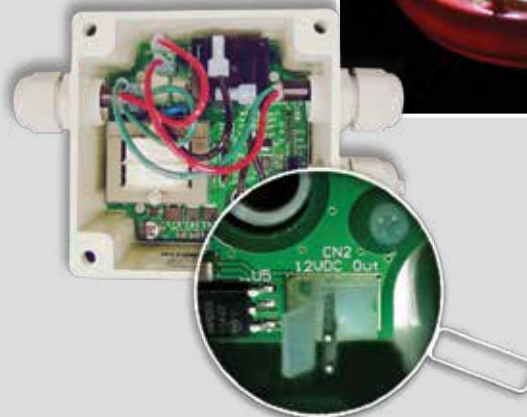

Proven & Dependable™

Cumberland excellence in feeder technology extends to a line of pan accessories. Long life, easy cleaning and reliability adds to the overall pan feeding performance.

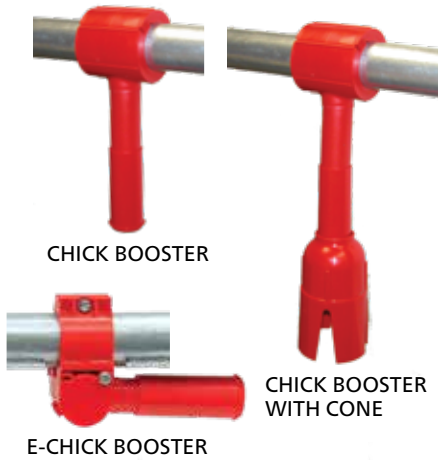

Chick Booster & E-Chick Booster

Cumberland's CHICK BOOSTER AND E-CHICK BOOSTER are available with or without cone. The cone restricts the feed flow amount to feed trays for one uniform feeding and less crowding. Cumberland feed trays provide the needed feed space in your broiler application.



Feed Line Hoppers

Light, durable, fully galvanized feed line hoppers are available in 120, 200, 300 and 400 lb. capacity. The standard hopper suspension allows removal of the feed hopper without affecting the feed line suspension when raising the feed lines. Optional feed hopper rotation suspension kits can be easily installed on existing or new feed lines allowing 90 degree hopper rotation with no feed hopper removal needed.



OPTIONAL FEED HOPPER ROTATION SUSPENSION KIT



Boots & Tubing

Heavy fabricated, galvanized, single and double outlet boots are available for end or center house feeding applications.

The rib on Cumberland's lock formed tubing gives added strength to the tube, as well as providing a solid way to hold the pans in place. The auger is manufactured from pre-flattened wire to reduce material stress and provide for a more consistent, high quality product.



Feed Hopper Switches

The Sens-O-Matic II feed hopper switch is a reliable way to regulate your feed delivery. An optional adjustable bracket kit allows the Sens-O-Matic to be conveniently adjusted to proper operation height. Traditional micro switches, proximity hopper level controls and Flex-Flo™ hopper level control switches are also available to regulate feed delivery.



IR-Plus™ Feed Sensor

The IR-Plus™ is specially designed to work hand and hand with Cumberland's Flex-Flo™ feed delivery system and i-plus3 Control Pan. This combination of dependable Cumberland products provide gentle feed handling, full hoppers and feed pans that will result in maximum feed efficiency.

- Adjustable time delay prevents the fill system from short cycling, extending motor and auger life
- Infrared sensors accurately detect feed flow to shut fill systems off when the hopper is full
- No moving parts or sensitivity adjustments for low maintenance, accurate feed levels every time
- Easy installation and retrofitable, adapts to nearly all flexible auger systems
- LED lights allow quick verification of operating status

Infra-Red Feed Sensing

With no moving parts or sensitivity adjustments, the IR-Plus™ ensures the feed level switch is activated every time. When the feed level drops below the sensors and the user defined time delay has elapsed, the fill system will start, bringing feed to the desired hopper.

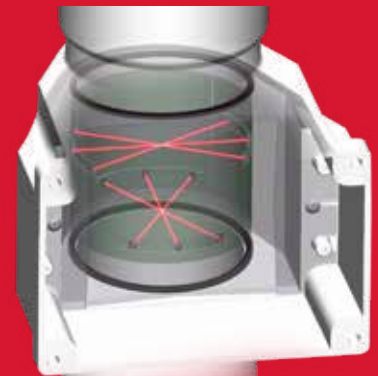

U.S. Patent 8,056,506

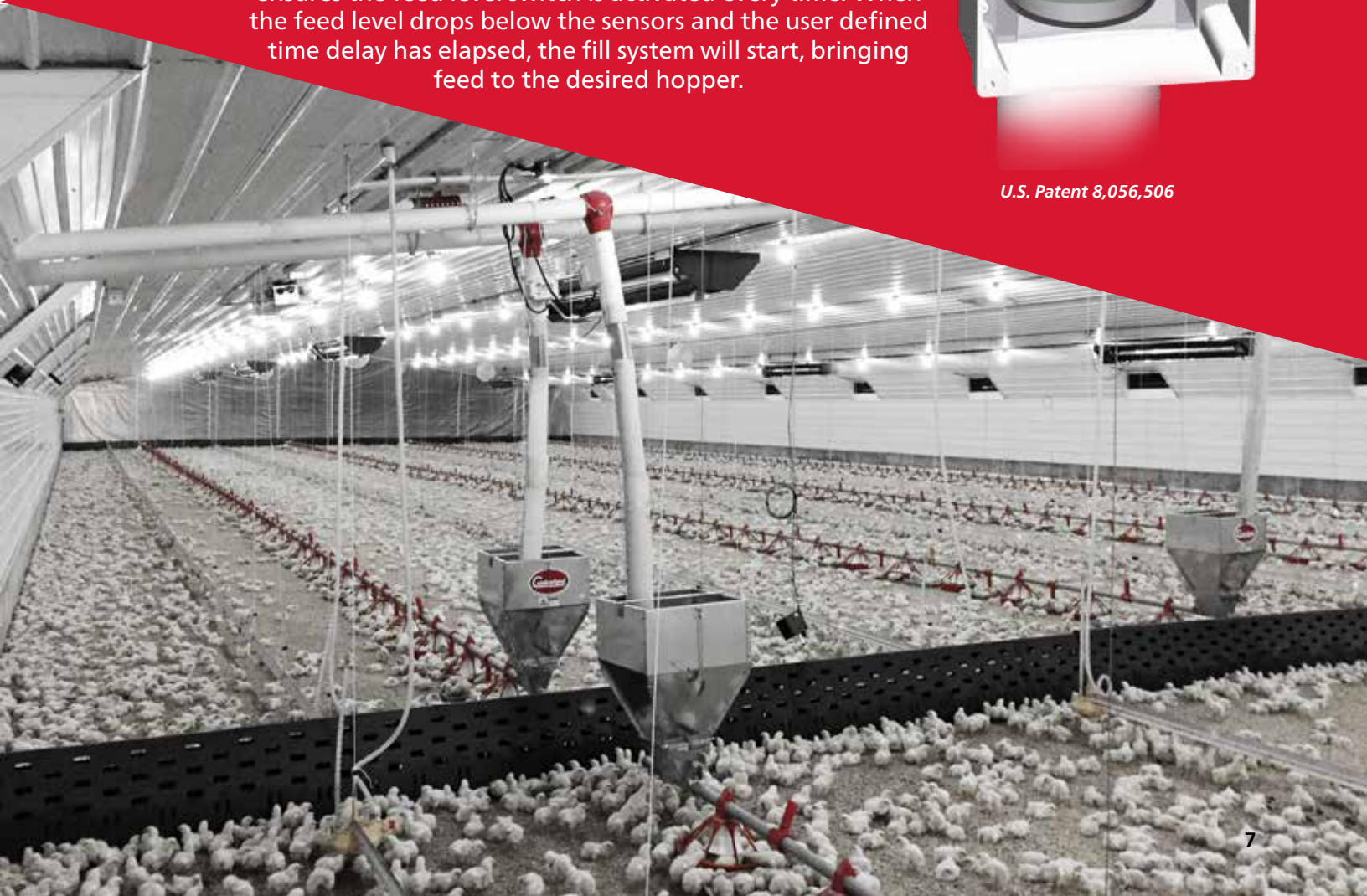

Watering Systems

Cumberland's experience and engineering continue to bring to you a complete watering system loaded with innovations and features that promote large healthy birds and dry floors.

Twin Lock

J-Lock

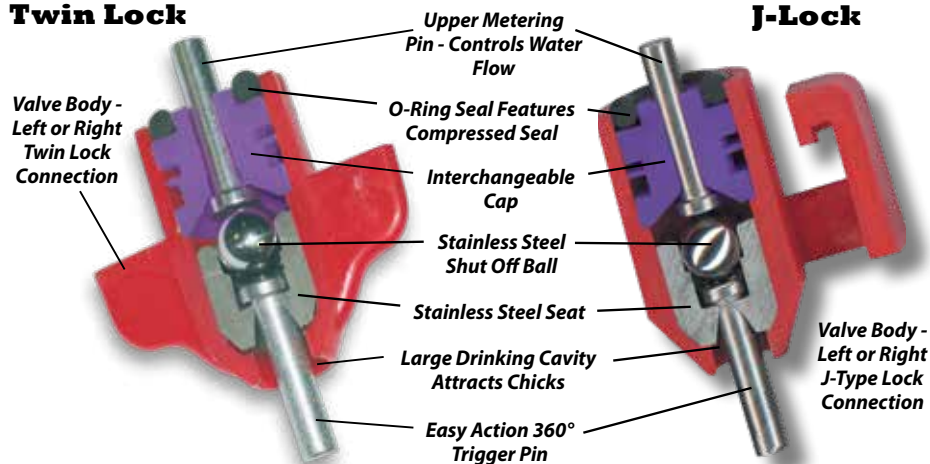

Twin Lock/J-Lock Nipple Valves

Six different nipple valves are available to meet your watering needs. A stainless steel upper pin provides long life and a precise flow rate. The valve design consists of only 3 moving parts for consistent and reliable operation. Twin Lock valves allow a wrench free assembly.

Support Options

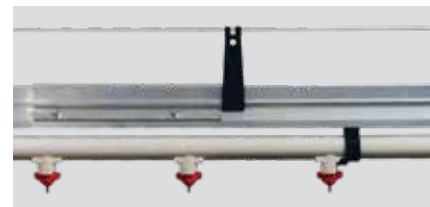

Aluminum Rail

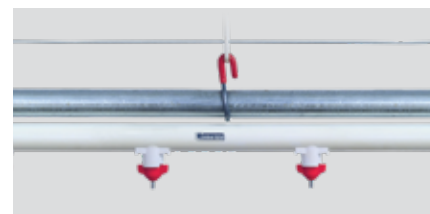

Round Pipe

Nipple Flow Rates

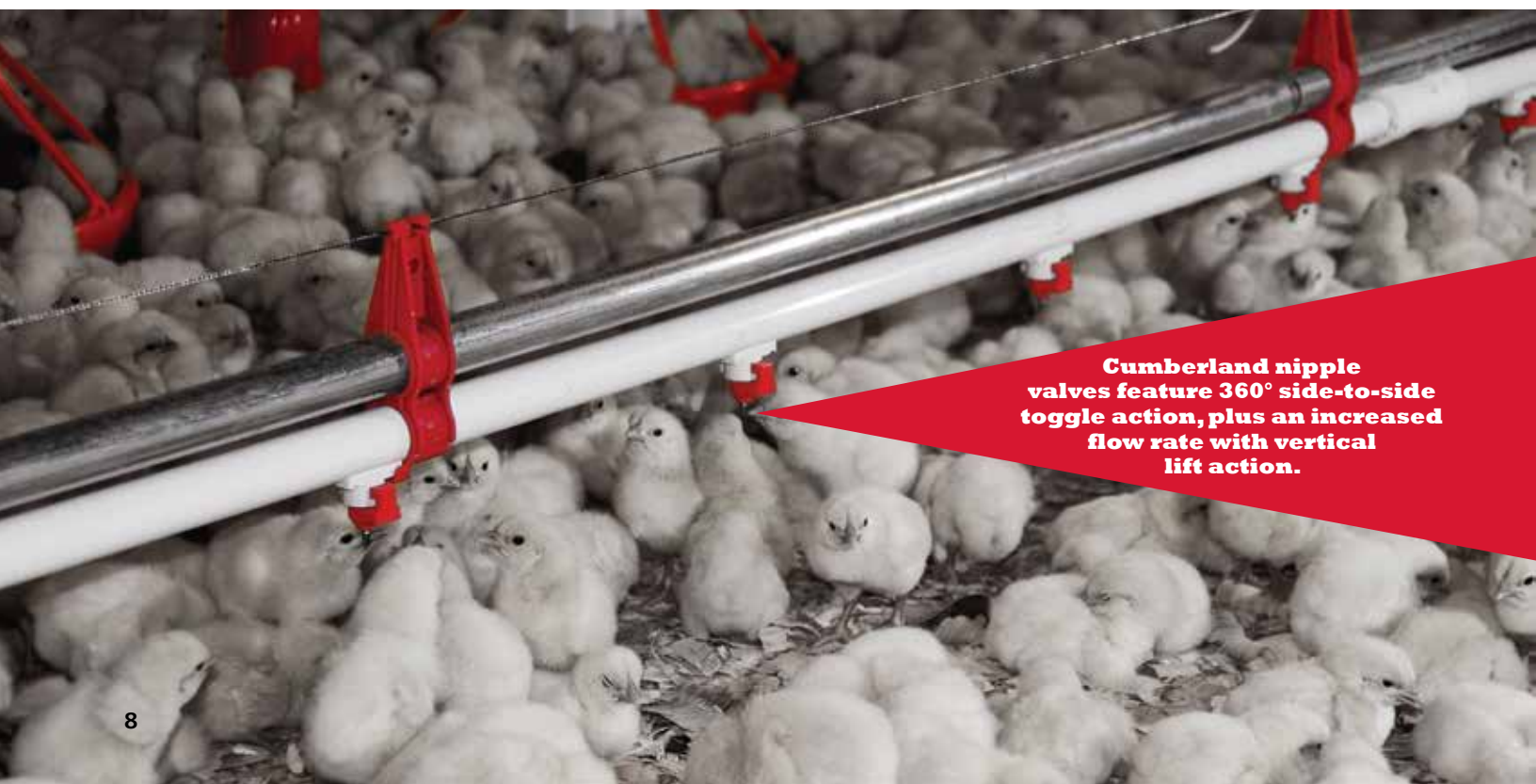
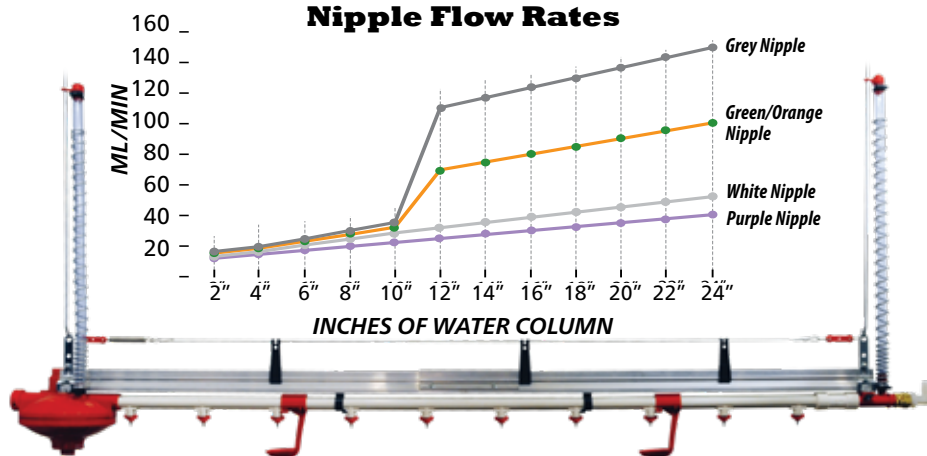

Cumberland nipple valves feature 360° side-to-side toggle action, plus an increased flow rate with vertical lift action.

Drinking Cups

The easy to install drink cup is available as an option on Cumberland's watering systems.



Support Rail Joints

Cumberland's aluminum rail join connectors are easy to install and provide a robust fit for your connection needs.



US Patent No. 7,090,261

Water Tight Connections

- External sealing "O-ring" connection allows unobstructed water flow
- No glue necessary
- 1.05" (27 mm) large volume pipe
- Simple push together assembly
- Keyed connection from regulator to end assembly
- Light resistant water pipe prevents algae

Self Sealing Caps

Self sealing caps are used at the clear sight tube to help prevent water spillage.

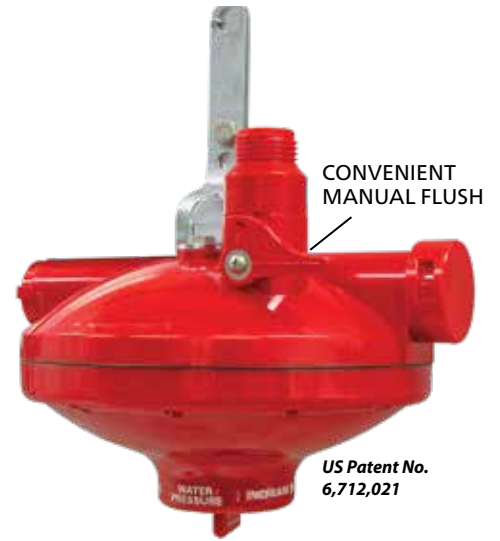

US Patent No. 6,712,021

Water Regulators

Cumberland's versatile water regulator is designed for ease of use with no by-pass necessary. It can be easily removed from the watering line without interfering with the watering line suspension.



Use as a mid-line regulator by simply removing the end cap

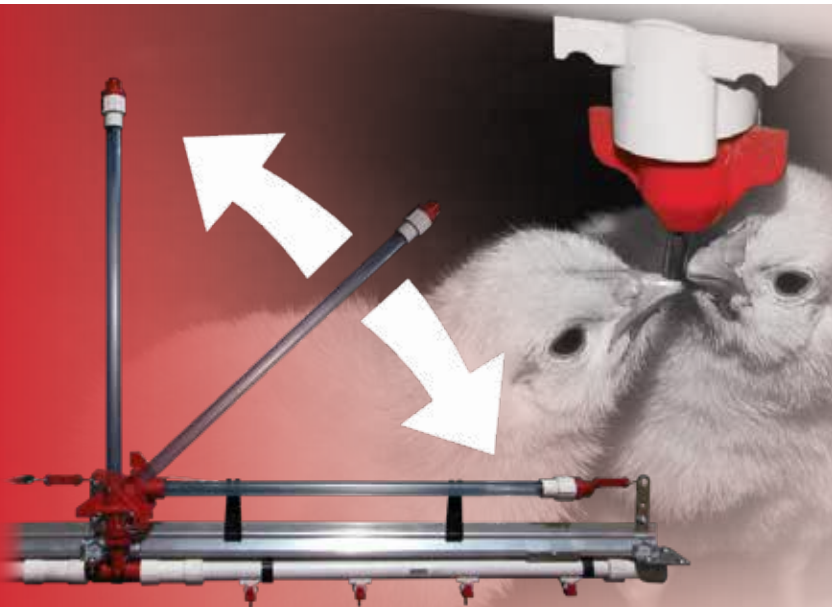

Collapsible Rigid Pipe

An optional collapsible rigid stand pipe is available providing unencumbered raising of the watering line.

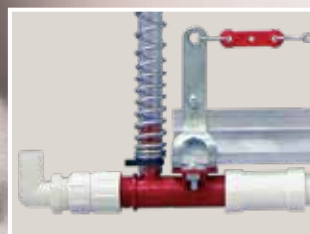

End Kit

- Tall flexible sight gauge allows for easy pressure reading
- Garden hose drain

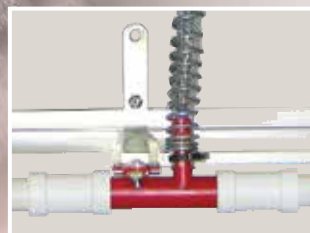

Air Vent

- Bleeds air from high spots
- Offers mid-line sight gauge reading

Feathersoft™ Nipples

The patented FeatherSoft Broiler Nipples are designed to meet the demands of today's broad poultry production needs. Choose between FeatherSoft Advantage Nipples and FeatherSoft Hi-Flow Nipples with LitterGard to design a system that best satisfies the needs of your unique broiler operation.

- 360° side action triggering
- Exact water metering at every age
- Simplistic design
- Square pipe advantage
- Trouble-free performance
- Corrosion resistant aluminum rails
- Simple and quick assembly



Watering sections are shipped completely preassembled. Only galvanized connectors and hangers are not assembled.



ONE-ARM LITTERGARD™ TWO-ARM LITTERGARD™



Tech Talk

Number of Birds per Nipple

10-12 - FeatherSoft Advantage

14-17 - FeatherSoft Hi-Flow with LitterGard

Nipples per 10' Section - Standard

10 nipples per 10' (3 m) Section

12 nipples per 10' (3 m) Section

15 nipples per 10' (3 m) Section

Max. Recommended System Length

250' (80 m) per Regulator

Water Pressure Requirement - 250' length

Pressure Regulator: min. 20 psi

(1.380 bars) max. 45 psi (3.103 bars)



OptiGROW™

The Ultimate Broiler Nipple Optimized for Growth

The OptiGROW nipple is designed to work in today's challenging broiler environment. Because the nipple has been optimized for growth, you will be amazed by the first-week low mortality results and increased weight gains on jumbo birds.

LOW THREAD PROTECTION

Less restriction of water flow for better flushing

INCREASED WALL THICKNESS

Thick walls offer a more robust design and better chemical resistance

LARGE BODY

The large body provides better visibility

HYGIENIC DESIGN

The new nipple body helps keep the nipple clean

EASY TRIGGERING

Less triggering force gets day-old birds off to a fast start

HYGIENIC SURFACE

The smooth inner surfaces avoid deposits and provide minimal friction for easier triggering

ACID-RESISTANT MATERIALS

The special quality and grade of materials used provide the best protection against acid corrosion

ADAPTER AREA

Accessories can be directly attached to the nipple body

LARGE DIAMETER PIN

The large diameter of the pin holds a large water drop

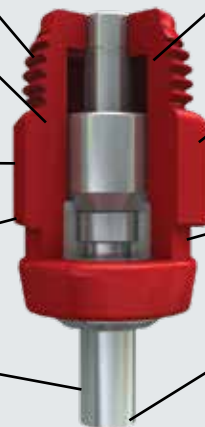

Radiant Heating

Allowing heat to be radiated directly to the birds allows them to find their own comfort zone either closer to, or farther away from, the heater. This reduces stress and creates an environment that allows for better bird performance.

Infra-red heat emulates the true efficiency of the sun. It generates energy that is converted into heat when absorbed by objects like floors and animals. The energy is then re-radiated to warm the surrounding area by convection.



Radiant Tube AG-1 or AG-2 Heaters

Radiant tube heaters include a heavy-duty control and burner unit and use outside air for combustion. The unique two stage burner adapts to varying conditions providing a more consistent comfort zone with fewer off cycles. Units operate at low fire the majority of the time for improved energy efficiency. High fire mode provides reserve heating capability when conditions require.

- 16 ga. aluminized combustion chamber - (First 10')
- Turbulator baffle for maximum efficiency
- 4" overlapping slip-fit tube connections
- High efficiency polished aluminum reflectors
- Two mounting options: center or side mount
- Solid state silicon carbide ignition system
- Unique anti-rattle reflector springs
- 24" PVC coated stainless steel flex connector
- Ignitor changeable without tools
- Bolted tube clamps
- 2 x 4 electrical junction box
- Air inlet collar standard
- 100% enclosed components
- 1/2" gas cock provided
- Reflector end caps

Patented Two-Stage Burner Technology

- Fuel savings
- Faster heat loss recoveries
- Improved comfort levels
- Reduction in equipment cycles
- Design protection benefits

Flexible Mounting Options for Optimal Heating

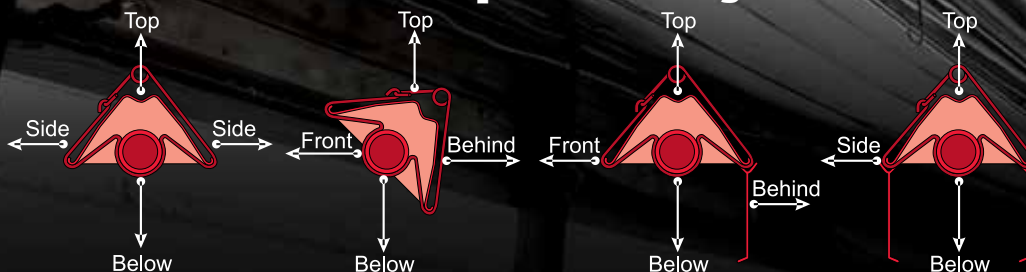

The Super-Saver and Tube Heaters are available in CE Certified models.

AV2 SERIES Tube Brooder

Uniform Heat Distribution

AV2 Series heaters utilize separate upper and lower tube temperatures and a series of reflectors to distribute heat more uniformly throughout the building, creating an even comfort zone for birds.



The AV2 Series upper combustion tubes contain the flame and operate at higher temperatures. Each tube has its own reflector allowing the hotter upper combustion tubes to concentrate more energy to the perimeter of the heating pattern.



The lower tubes are designed to distribute a lesser radiant energy resulting in reduced hot spots directly under the units and more uniform floor temperatures across the house. The U-bend at the end of the heaters have a separate end reflector directing the energy outwards, allowing optimum uniformity between units.

The AV2 Series Tube Brooder uses four tubes mounted in a V-Shaped pattern to direct the heat where it's most needed.

- No exposed flame to be effected by air flow or environment
- Totally enclosed electronics and burner system
- The highly polished aluminum reflectors allow optimum heat pattern for best uniformity
- Offered with Dual Stage Technology to maximize fuel efficiencies
- Low pressure system eliminates need for high pressure gas lines inside house
- Minimal assembly required
- Fresh air intake kit (attic version) with 4"x29" duct pipe, intake cap, chain hanging kit, and exhaust flapper cap are standard with each heater.
- Indicator lights display if unit is in low or high fire at a glance
- Easily access key components through an end service panel without having to remove the heater from suspension chains.
- Single Stage BTU: 80,000, Dual Stage BTU: 50,000 - 80,000
- Option to vent exhaust outside
- Option to duct fresh air from other locations than attic to ensure clean combustion and reduce maintenance



Just what are people saying about the AV Series Tube Brooder?



"Approximately 10% fuel savings; they produce a more even heat pattern; they heat up quicker, are quicker to setup; very satisfied with the heaters."

*John Holbert - Grower
JCG Farms - Calhoun, GA*



"Growers are pleased with fuel savings, ease of maintenance, consistent heat patterns, and ability to pre-heat the house quicker."

*Mark Bellamy - Broiler Manager
Pilgrims - Athens, GA*



"Would highly recommend the AV heater. Preheat time is drastically reduced and it maintains a consistent and uniform floor temperature. We estimate 25% efficiency savings the 1st year."

*Paul Sanders - Grower
Pilgrims - Athens, GA*



"AV Heaters have improved gas usage and chick uniformity. Heat patterns indicate floor temperature is maintained."

*Charlie Howington - Broiler Manager
Marjac Poultry - Gainesville, GA*



"Most uniform heat I've seen with very little maintenance and upkeep."

*Michael Cronin - Broiler Manager
Columbia Farms, Lavonia, GA*

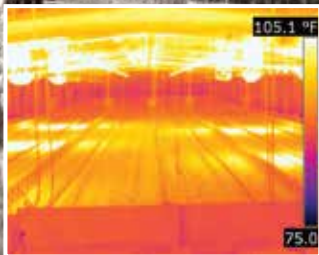
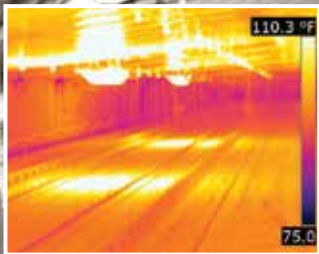

AV Series Heat Distribution - Infrared photos courtesy of Auburn University, National Poultry Technology Center (House pictured is 66' wide)

AV2 SERIES SPECIFICATIONS

Heating Capacity (Maximum per Hour)			
Direct Spark Ignition (3 Tries Before Lockout)		80,000 BTU	20,160 Kcal
Maximum Gas Consumption			
LP		.87 gph	3.29 l/h
Natural Gas		75.5 cfh	2.14 m3/h
Gas Pressure Requirements (Measured on Pressure Tap on Valve with Unit Running)			
LP	Minimum	11.0" wc	Maximum 14.0" wc
NG	Minimum	5.0" wc	Maximum 14.0" wc
Heater Size & Weight Information			
Weight Per Complete Unit		140 lbs.	64 kg
Shipping Dimensions - Burner Box 31.5"L x 17.5"W x 15.5"H, Tube Box 98.5"L x 29.25"W x 13"H			
Installed Dimensions (LxWxH)		112"x25.5"x13"	285x65x33 (cm)
Installation Guidelines			
Minimum Height from Floor (Measure from Floor to Bottom of Unit)		6 - 9 Feet	1.8 - 2.7 Meters
Space Between Heaters		40 - 60 Feet	12.2 - 18.3 Meters
Minimum Clearance to Combustibles			
Sides of Heater		36"	91 cm
Above Heater		10"	25 cm
Below Heater		40"	102 cm
Electrical Requirements			
AVD (Dual Stage) - 120v 60Hz GRD, 3 wire, 24vac thermostat connection			
AVS (Single Stage) - 120v 60Hz GRD, 3 wire			
Starting Current - 1.5 amps			
Running Current - 1.1 amps			
Sensor Location Specifications			
Sensor should be placed over the feed or drinker line.			
Sensor should be no more than 12' to the side from the center of the unit and 10' length wise from the end of the unit.			

Variable Rate Heating with Less Hassle

The VariFlame variable rate heater offers producers more control, easier access and increased longevity compared to any other unit available on the market today. Pair the VariFlame in legacy mode with any controller, seamlessly synchronizing and adjusting with the temperature curves set in the controller to maintain desired room temperature.

Improved Burner Performance

Most variable rate heaters range from 65,000 to 250,000 BTU's. VariFlame's line-style burner offers an extended range of 50,000 to 250,000 BTU's. This allows the heater to run longer while improving heat distribution and humidity control. Even while operating at lower BTU's, the line-style burner provides a more consistent flame while maintaining ignition reliability, flame sense and flame stability.



No More Igniter Frustration

Our new igniters are the most durable and easy-to-use on the market. Made of silicon nitride, a material typically used in performance engine parts, these igniters replace silicon carbide models. They reach hotter surface temperatures and will last significantly longer due to a dust-inhibiting design that reduces carbon buildup.

Standard Diagnostics

The on/off model VariFlame multi-color LED diagnostic system combines several colors and frequencies to offer more precise information.



Longer Life

VariFlame is the first heater offered with all 304 stainless steel shell and internal components. This corrosion-resistant and durable construction increases the lifespan and saves you money. VariFlame is also available in galvanized and painted galvanized metal with aluminized steel internal components, offering increased corrosion resistance and longevity.

All models come with our water and dust tight control box for long life and the industry's highest grade FEP-coated wires and stainless steel terminals.

Easy Maintenance

Maintenance is easy with VariFlame. It is the only heater on the market featuring a single, easy-to-remove door that allows you to effortlessly access all serviceable parts from a single location. Plus, every aspect of the heater can be serviced using a single tool – 1/4" nut driver. The removable grill guard allows you to easily clean out the blower wheel ensuring that your heater always runs at peak performance.



Standard Accessories

- **Air Diverter Kit** – allows you to place the air flow in the position of your choice: Y-duct, T-duct or straight through
- **Hanging Kit** – hooks and chain allow you to hang the heater from the ceiling
- **Sediment Trap** prevents debris from entering the gas valve



VariFlame™

EDGE

VariFlame with EDGE® Connect has been designed to work seamlessly as a standalone heater or in legacy mode using on/off outputs such as the Evolution, Pro Vision or competitive controller. When connected to the EDGE® control system, advanced features such as stir fan mode, exercise mode, remote access and remote diagnostics are available. This is all possible through the patent pending control system inside the VariFlame EDGE® Connect model heaters.



VariFlame™ Heaters Specifications	Vapor Propane	Natural Gas
Maximum Input	250,000 (BTUH)	250,000 (BTUH)
Minimum Input	50,000 (BTUH)	50,000 (BTUH)
Inlet Gas Supply Pressure Max	13.5 in. W.C.	13.5 in. W.C.
Inlet Gas Supply Pressure Min	12.0 in. W.C.	7.0 in. W.C.
Fuel Consumption Per Hour Max	11.58 lbs.	238 cu. ft.
Fuel Consumption Per Hour Min	2.32 lbs.	47.6 cu. ft.
Motor Characteristics RPM	1/3 H.P., 1100 RPM	1/3 H.P., 1100 RPM
Electric Supply (Volt/Hz/Phase)	115/60/1	115/60/1
Amp Draw (Starting)	9.5	9.5
Amp Draw (Continuous)	4.5	4.5
Min Combustion Distance Top	1 ft.	1 ft.
Sides	1 ft.	1 ft.
Back	1 ft.	1 ft.
Blower Outlet	6 ft.	6 ft.

ACS Direct Spark Radiant Brooders

A consistent, stress-free environment promotes healthier, more productive animals. Radiant heaters provide a consistent, clean-burning and fuel-efficient source of warmth for all types of poultry houses.

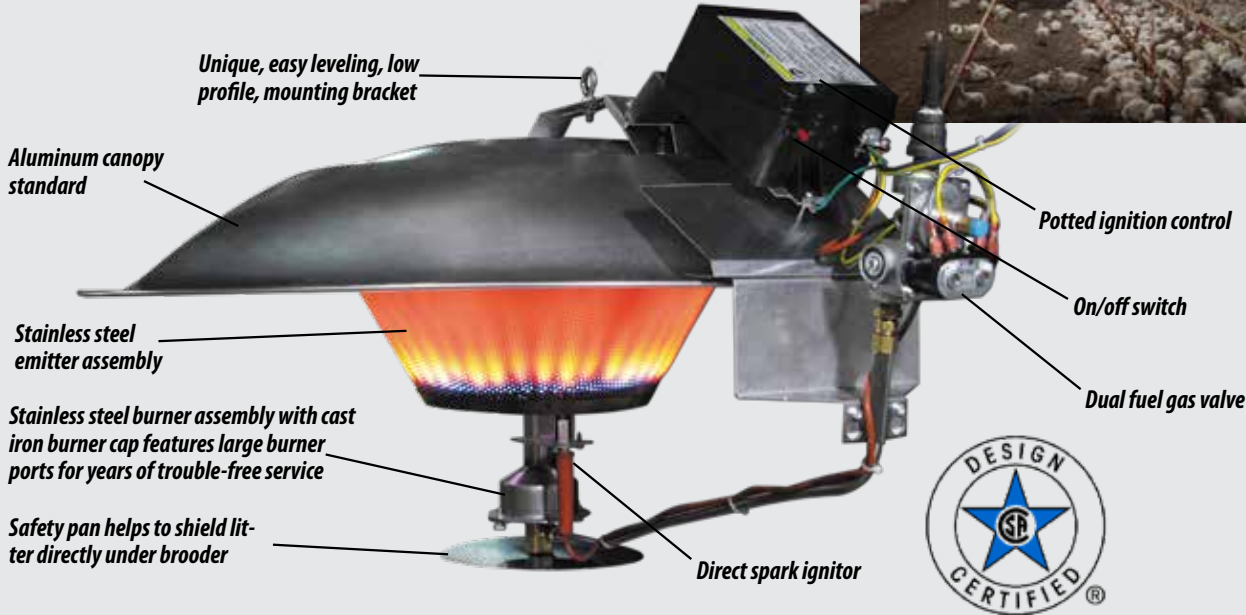

FEATURES & BENEFITS

- Enclosed potted ignition control protects components from humid and dusty environments
- 2 & 6 unit packaging combinations for transportational ease
- 3-try direct spark ignition before lockout
- On/off toggle switch for on the spot serviceability without engaging house controller
- Symmetrical heat pattern with reduced hot spots



ACS Direct Spark Specifications	ACS-40P-24V	ACS-40N-24V
Gas Type	Propane	Natural
BTU/h Input	40,000	40,000
Reflector Capacity Diameter	35"	35"
Brooder Height	18"	18"
Standard Weight	27 lbs	27 lbs
Recommended Mounting Height*	5' to 6'	5' to 6'
Gas Connection	3/8" NPT	3/8" NPT
Manifold Pressure (Inches W.C.)	10"	3.5"
Gas Orifice Size	1.9 mm	3.1 mm
Primary Voltage	24 VAC	24 VAC
Unit Total Amps	0.5	0.5
Inlet Pressure** (Inches W.C.)	11-14"	5-14"

APPROVALS & CERTIFICATIONS:

IAS U.S. Req. No. 8-94
CAN 1-2.20-M85
Indoor (non-residential) approval
Agricultural approval

INPUT RATING:

40,000 BTU/H (11.72 kw)

GAS TYPE:

Natural or Propane Gas

The zone control panel allows you to control up to 30 brooders from one place. It also features a battery backup, four fused zone connections and one thermostat.



Cumberland's durable thermostat ensures accurate, automatic operation and are moveable for your convenience.



Galvanized Steel Fans

All galvanized fans are constructed of heavy gauge, G-90 grade galvanized steel and use totally enclosed "TEAO" motors designed for high efficiency and continuous duty cycles.

Mega Flow Butterfly Fans 36", 50", 52" and 54" Diameter

Mega Flow Butterfly Series Fans have been re-engineered for improved air flow and greater efficiency. Available in 36", 50", 52" and 54" diameters, Mega Flow Butterfly fans are easy to install, extremely low maintenance and include many new features designed to save you time and money.

- Front shutter doors offer protection while the fan is not in use from harsh weather conditions such as wind and moisture
- Arched side cone panels allow Cumberland fans to be mounted closer together on field installation
- Large pulleys allow for longer belt life and smooth operation. An automatic belt tensioner ensures proper belt tension
- Air diverters for improved airflow



- Strong ring weldment with rod and V-channel vertical
- Revised baffle spring attachments
- Neoprene baffle hinge for smooth, consistent operation
- Large, cast iron, high quality greasable pillow block bearings are used for longer life
- Bell or cage inlet options



Flush Mount Panel Fan

More airflow and easy installation

Cumberland is proud to introduce the Flush Mount Panel Fan to meet your specific high efficiency or high airflow requirements. The flush mount design features a tight seal to limit light and air leakage, collapsible sides for closer fan installation, and adaptability to a wide range of rough opening sizes for easy installation or retrofit.

- Mounts to the outside of the frame opening
- Can be installed on 5-foot centers
- Tight seal limits light and air leakage
- Collapsible sides allow more fans on a wall
- Heavy-duty, galvanized cone, venturi and props
- Adapts to a existing rough opening sizes for easy retrofit capability
- 2-year motor warranty





Slantwall Fan

- Available in 36", 50" and 54" diameters
- Aerodynamically balanced propellers for maximum airflow
- Heavy-duty, galvanized cone, venturi and props
- 2-year motor warranty

SHOWN WITH OPTIONAL DISCHARGE CONE



Box Fans

- Available in 36" dia. (14" and 19" depth) or 50" dia. (21" and 25" depth)
- Aerodynamically balanced props for maximum airflow
- Heavy-duty, galvanized steel housings, venturis and propellers.
- 2-year motor warranty

GALVANIZED SLANTWALL, SLANTWALL CONE & BOX FAN PERFORMANCE VALUES

Model	Dia.	Drive	Type	HP	0.0 Static Pressure		.05 Static Pressure		.10 Static Pressure		BESS Lab Test#
					CFM	CFM/Watt	CFM	CFM/Watt	CFM	CFM/Watt	
CGSB36	36"	Belt	Slantwall	0.5	10578	19	9984	17.1	9379	15.5	98273
G50SL16GA	50"	Belt	Slantwall	1	22373	18.6	21042	17	19595	15.5	98283
CGSD36	36"	Direct	Slantwall	0.5	10417	17.5	9747	15.8	9105	14.2	94-0015
CGSD50	50"	Direct	Slantwall	1.25	20400	19.2	19300	17.5	18100	15.8	94328
CGBB3614	36"	Belt	Box	0.5	10171	19.6	9615	17.8	8969	15.8	00128
CGBB5021	50"	Belt	Box	1	20861	20.9	19486	19.1	18071	17.4	94276
CGBD3614	36"	Direct	Box	0.5	10950	19.3	10280	17.7	9560	16	94131
CGBD5021	50"	Direct	Box	1.25	20450	19.09	19200	17.8	17910	15.9	94283
CGSBC36	36"	Belt	SW Cone	0.5	11341	20.9	10653	18.4	9898	16.4	98275
G50SCL16GA	50"	Belt	SW Cone	1	24700	22.5	23100	20	21500	17.7	3168
G54SCL16GA	54"	Belt	SW Cone	1.5	28900	27.1	26700	23.6	24300	20.4	-
G54SCL16GHF	54"	Belt	SW Cone	1.5	30856	24.0	29184	21.3	27185	18.8	-

* Performance values of this fan at .05" static pressure exceeds the BESS Lab test capabilities and were calculated through regression analysis of CFM and CFM/Watt measurements.



GALVANIZED BUTTERFLY FAN PERFORMANCE VALUES

Model	Dia.	Drive	HP	0.0 Static Pressure		.05 Static Pressure		.10 Static Pressure		.15 Static Pressure		.20 Static Pressure		BESS Lab Test#
				CFM	CFM/Watt	CFM	CFM/Watt	CFM	CFM/Watt	CFM	CFM/Watt	CFM	CFM/Watt	
77-0104-IB	36"	Belt	0.5	-	-	11065	17.4	10575	16.1	-	-	-	-	NA
77-0100-IB	36"	Belt	0.5	12580	19	11700	16.5	10840	14.5	9940	12.7	8950	11.1	8265
77-0109-IB	50"	Belt	1.5	25238	27.4	23524	24.0	21800	20.8	19400	17.7	17000	14.9	4309-C
77-0110-IB	50"	Belt	1.5	23915	30.2	22131	25.9	19937	22.1	17700	18.5	15100	15	4310-C
77-0111-IB	50"	Belt	1.5	26913	24.2	25427	21.5	23603	18.9	21600	16.4	19500	14.2	4308-C
77-0118-IB	52"	Belt	1	29300	25.6	27700	22.6	25900	19.6	23700	16.9	21500	14.5	5336
77-0117-IB	52"	Belt	1.5	27600	29.1	25900	25.2	23800	21.7	21500	18.2	18800	15.2	5340
77-0121-IB	52"	Belt	1	27800	28.3	26000	24.2	24000	21.0	21300	17.5	18900	14.7	5337
77-0122-IB	52"	Belt	1.5	30700	25	29200	22.1	27500	19.4	25600	17	23400	14.7	5338
77-0143-IB	54"	Belt	1.5	32300	22.9	30800	20.5	29300	18.4	27500	16.4	25400	14.4	14156
77-0144-IB	54"	Belt	1.5	31800	23.7	30300	21.2	28700	19.0	27000	17.0	23900	14.0	14157
77-0145-IB	54"	Belt	1.5	31100	24.6	29700	21.9	28000	19.5	26200	17.4	23900	15.0	14185
77-0146-IB	54"	Belt	1.5	30800	25.0	29500	22.5	27800	20	25800	17.6	23600	15.2	14182
77-0147-IB	54"	Belt	1.5	30000	26.4	28400	23.5	26600	20.7	24600	18.0	22300	15.6	14159
77-0148-IB	54"	Belt	1.5	29600	27.5	27900	24.1	26100	21.2	24100	18.7	21800	15.8	14158
77-0149-IB	54"	Belt	1.5	29200	27.7	27600	24.4	25800	21.6	23700	18.6	21200	15.9	14183
77-0150-IB	54"	Belt	1.5	28400	27.7	26700	24.4	24900	21.6	22500	18.6	20100	15.9	14160
77-0151-IB	54"	Belt	1.5	27800	30.5	26000	26.4	24000	22.7	21600	19.3	18000	15.1	14172

NOTE: Listed RPM at .10" static pressure.

HIGH-EFFICIENCY FLUSH MOUNT PANEL FAN

591 to 594 RPM with 0.10 static pressure. Our most energy efficient flush mount fan option.



STATIC PRESSURE (IN H ₂ O)	AIRFLOW (CFM)	RPM	VOLTS	AMPS	WATTS	CFM/WATT
0.00	29500	594	230.1	5.11	1128	26.1
0.05	28200	593	229.7	5.41	1191	23.7
0.10	26500	592	229.7	5.71	1260	21.0
0.15	24800	591	230.2	6.03	1334	18.6

HIGH-FLOW FLUSH MOUNT PANEL FAN

628 to 633 RPM with 0.10 static pressure. Our highest RPM flush mount fan option moving up to 520 cu. ft. per second.

STATIC PRESSURE (IN H ₂ O)	AIRFLOW (CFM)	RPM	VOLTS	AMPS	WATTS	CFM/WATT
0.00	31200	633	231.5	5.97	1329	23.4
0.05	30000	631	230.4	6.37	1410	21.3
0.10	28600	630	229.7	6.71	1482	19.3
0.15	26800	628	229.7	7.06	1559	17.2

Fiberglass Fans

Cumberland's fiberglass fans are manufactured using a resin transfer molding process for a smooth finish on both interior and exterior surfaces of the fan housing.

58C Series Fans

Get powerful ventilation from our highest performing fan featuring a spring* loaded butterfly door design with a magnetic locking mechanism for a complete seal.

- 58" diameter fan with non-corrosive fiberglass reinforced composite venturi and housing
- Tight sealing butterfly door design reduces air leakage and light infiltration
- Preassembled butterfly doors and standardized fasteners make assembly quick and efficient
- Non-corrosive composite cone available



58C Series



Light weight, insulated poly butterfly dampers open and close automatically with the operation of the fan.



Rigid x-wing motor mount design and reinforced corner bracing add strength and solid support with minimal air flow obstruction.



Standard, automatic belt tensioner and large, cast iron, greasable pillow block bearings for longer life.



An extended housing allows the fan to be mounted flush with the internal wall surface. The flush mount design allows retrofit over wall openings from 57.5" to 63".

58C FAN PERFORMANCE VALUES

Part#	Type	.10 Static Pressure		.15 Static Pressure		.20 Static Pressure		Air Flow Ratio	Bess Labs Test No.	Power
		CFM	CFM/Watt	CFM	CFM/Watt	CFM	CFM/Watt			
77-0185	High Flow	30,000	20.5	28,300	18.6	26,200	16.7	0.83	17305	230V, 60Hz, 1PH
77-0183	High Efficiency	26,700	22.6	24,800	20.3	22,500	17.9	0.78	17304	230V, 60Hz, 1PH
77-0188	High Flow	29,400	20.6	27,600	18.5	25,700	16.7	0.83	17211	230V, 60Hz, 3PH
77-0189	High Efficiency	27,100	22.8	25,000	20.2	23,000	18.0	0.80	17210	230V, 60Hz, 3PH

58C FAN DIMENSIONS

A	B	C	D	E	F	Recommended Wall Opening
12.25"	45.00"	16.13"	68.13"	76.00"	65.75" x 65.75"	66.00" x 66.00" **

** For flush mount installations, the Mega Flow 58C will accommodate openings from 57.5" to 63" square. Fan to Fan spacing on wall with poly cone: 76"

*Patent Pending

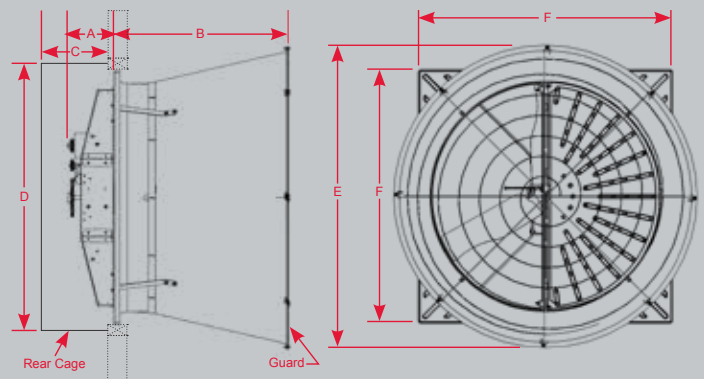



Performer Series

Models available with or without cones



Competitor Series

Performer Series Fans

High performance, efficiency, and longevity make the 36" and 50" Performer series fans a popular choice for optimal airflow. Propellers



are made of a tough composite fiberglass and engineered with a true airfoil design that increases the overall efficiency of the fan. Drive shafts of 1" material allow for large, cast iron, greasable pillow block

bearings to be used for longer life. Large pulleys allow for longer belt life and smooth operation.

Competitor Series Fans

Capable of moving up to 30,000 cubic feet of air per minute, Competitor Series fans are another powerful tool to help you compete in today's world



marketplace. Features include a 1.75 HP single or three phase motor, easy belt access, fiberglass housing and cone, and stainless steel hardware. The belt driven 54" competitor series fan features an automatic belt tensioner for smooth

operation. Like all Cumberland belt drive fiberglass fans, cast iron pulleys and greasable pillow block bearings are standard features.

PERFORMER AND COMPETITOR FAN PERFORMANCE VALUES

Model	Dia.	Drive	Cone	HP	0.0 Static Pressure		.05 Static Pressure		.10 Static Pressure		BESS Lab Test #
					CFM	CFM/Watt	CFM	CFM/Watt	CFM	CFM/Watt	
APPB-36	36"	Belt	No	0.5	10952	16.1	10152	15.4	9339	14	-
APPB-36C	36"	Belt	Yes	0.5	11232	18.2	10905	17.5	10135	15.8	-
APPB-50	50"	Belt	No	1	21508	17.6	20160	15.7	18707	14.4	-
APPB-50C	50"	Belt	Yes	1	24282	23.4	22760	21	21129	19	01251
CS54C1-P	54"	Belt	Yes	1.75	32125	-	30044	20.2	28157	18.3	-

Cumberland shutters can provide an easy and affordable means of controlling incoming light and building climate. Shutters are available in white or black PVC, galvanized with epoxy painted blades and durable aluminum.



Factory assembled, pre-wired, 20" circulation fans are available for light air movement. These highly efficient 20" fans include 1/10 HP "TEAO" motors and galvanized props for whisper quiet operation. Other features include PVC coated guards for durability and multi-application hanging bracket.



2-Bladed Circulation Fan

3-Bladed Circulation Fan

Curtain Machines

Protect the health of your investment with a properly controlled curtain system. Cumberland's curtain machines deliver powerful performance and reliable operation with durable components to withstand a rigorous environment.



CURTAIN CONTROLLER

Cumberland's Curtain Controller is a screw driven automated curtain machine with a heavy duty 15, 30 or 60 RPM motor. Multi-directional, frame mounted, header pulleys and latch out assembly come standard.

A plastic water resistant junction box is accessible from the outside of the curtain controller.



The drive block assembly features a removable nylon insert in a heavy-duty cast iron drive block simplifying cable/chain installation and ease of maintenance. This design also decreases friction and provides wear characteristics superior to conventional brass drive blocks. UHMW polyethylene guide wheels insure smooth travel, proper alignment and stability.



Solid construction and rust resistant materials make the sprocket controller a reliable workhorse year after year.



The Curtain Controller utilizes a threaded block and drive screw directly coupled to a direct drive gear motor.



Isolated primary and secondary limit switches allow for backup protection.

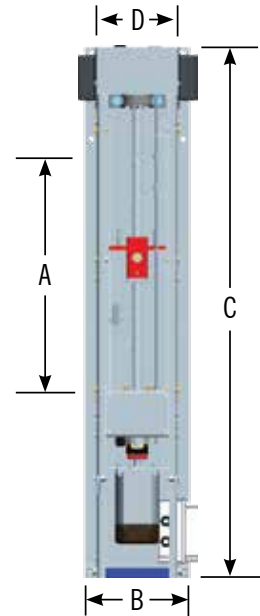

Model	H. P.	Voltage	Frequency	AMP Draw	Travel Speed	RPM
15 RPM Curtain Controller	1/12	115V	60 Hz	1.0 Amps	3" per minute	15
30 RPM Curtain Controller	1/8	115/220V	50/60 Hz	1.7 Amps	6" per minute	30
60 RPM Curtain Controller	1/6	115V	60 Hz	1.8 Amps	12" per minute	60
A.T. Newell	1/2	115V	60 Hz	6.0 Amps	3" per minute	1725

Curtain Commander Length	"A" Travel	"B" Width	"C" Length	"D" Width Less Flange	Weight
24" (61 cm)	22" (55.9 cm)	10.2" (25.9 cm)	52" (132.1 cm)	9.5" (24.1 cm)	110 lbs. (49.9 kg.)
36" (91.4 cm)	34" (86.4 cm)	10.2" (25.9 cm)	64" (162.6 cm)	9.5" (24.1 cm)	130 lbs. (58.9 kg.)
48" (121.9 cm)	46" (116.8 cm)	10.2" (25.9 cm)	76" (193 cm)	9.5" (24.1 cm)	150 lbs. (68.0 kg.)
60" (152.4 cm)	58" (147.3 cm)	10.2" (25.9 cm)	88" (223.5 cm)	9.5" (24.1 cm)	160 lbs. (72.6 kg.)

Hardware kits are available with heavy duty galvanized steel components.





POWERTRAK[®] Vent Machine



Operate attic inlets, vent doors, and other items requiring a 12" or less controlled movement at, or under, a 2,000 lb. capacity with the PowerTrak™ Vent Machine. Designed for a wall or ceiling mounted indoor installation, this machine will provide a more cost effective way to operate your vent inlet applications. The PowerTrak Vent Machine is available in 15 or 30 RPM models and can be ordered in either 120v or 240v single phase units. (Note: 240v units available in 50/60hz)

- Machine designed specifically for vent inlet applications
- 15 or 30 RPM - 120v, 60hz, 1ph
- 30 RPM - 240v - 50/60hz, 1ph
- 42.5" overall machine length for tight areas or short walls.
- Maximum travel length on rod is 12"
- Threaded block/drive screw directly coupled to DD gear motor
- Hardware included for cable or chain connection



Composite load nut offers increased life expectancy over brass.



The door hinges from the top of the cabinet on a ceiling mount or can be easily removed on a wall mount for unobstructed access to components.



Channel lock "trak-drive" system captures load block



Easy adjust spring-cam limit switch system



POWERTRAK[®]



With a 5,000 pound capacity, the superior quality and design of the PowerTrak™ linear drive system boasts many performance and durability enhanced features.

- Modular construction for ease of service.
- Built in head bracket with needle bearing pulleys.
- Channel lock "trak-drive" system captures load block.
- 15% increase in load block support surface for greater life.
- Easy adjust spring-cam limit switch system.
- Convenient, easily removable, hinged springlock door.
- Greater protection from the elements.
- Upper and lower auxiliary contact for enhanced Evolution features.



Cumberland's sidewall vent doors are used in poultry applications where transitional ventilation is required.

Part Number	Description	CFM @ .10 SP	Rough Opening
SWI-1700	Curved Sidewall Vent with Plastic Door & Galvanized Frame	2,250	10.75" x 41.5"
SWI-2000	Curved Sidewall Vent with Plastic Door & Galvanized Frame	2,550	10.5" x 46"



The all plastic Curved Sidewall Vent Door directs fresh air into the house along the ceiling toward the peak for gentle air mixing without downdrafts on the birds.



Also available in an all galvanized door construction, Cumberland vent doors are simple to install and provide years of optimum circulation.

Easy Install Attic Vents

Cumberland's Attic Vent ACI Series is precision engineered to extract solar heat from the attic space so it can be used as a valuable heat source. This unique and innovative design is cost effective, durable and easy to install.

- Drier litter
- Lower ammonia concentration levels
- Better environment for your birds



Incorporating all of the same benefits of the ACI-2500 and ACI-4000 Series, Cumberland's PACI-2500 Series vents are pressure actuated and operated by constant force of static pressure controlled springs.



Designed to be retrofit friendly in most drop ceiling poultry houses.

Part Number	Description	Full Open Airflow @ 0.10 SP	Horizontal Airflow @ 0.10 SP	Framed Opening
ACI-2500P2	All Plastic Actuated Ceiling Inlet	2500 CFM	1700 CFM	19" W x 27" L
ACI-2500GP2	Actuated Ceiling Inlet (Galvanized Frame)	2500 CFM	1700CFM	21.5" W x 27" L
ACI-4000P2	All Plastic Actuated Ceiling Inlet	4000 CFM	2500 CFM	19" W x 46.5" L
ACI-4000GP2	Actuated Ceiling Inlet (Galvanized Frame)	4000 CFM	2500 CFM	21.5" W x 46.5" L
PACI-2500GP2	Plastic 2500 Pressure Actuated Attic Vent (Galvanized Frame)	2100 CFM	1300 CFM	21.5"W x 27"L
PACI-2500P2	All Plastic 2500 Pressure Actuated Attic Vent	2100 CFM	1300 CFM	19"W x 27"L

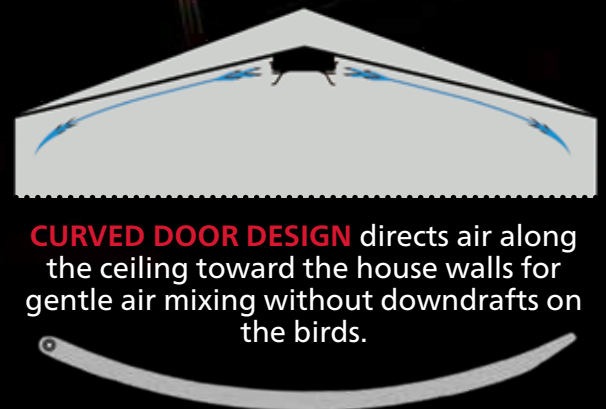

CURVED DOOR DESIGN directs air along the ceiling toward the house walls for gentle air mixing without downdrafts on the birds.

Mixing warm air from the attic with house air during minimum ventilation reduces fuel consumption as compared to using cold air through sidewall inlets. Fuel savings can vary depending on management, house construction and climate.



Tunnel Inlet Doors

Tunnel inlets help to eliminate dead zone areas created by curtain sidewalls and curtain pockets. The Inlet Door System comes fully assembled and is a rigid laminate foam panel that is ultra lightweight for easy installation.

- Fully assembled and easy to install
- Low maintenance lightweight doors
- End channels are pre-notched for proper, quick and easy installation
- Aluminum channels add rigidity to the door panels
- Energy efficient
- Available in 4', 5', & 6' heights
- Available in two colors; Black or White



Cumberland's formed rubber seal (profile shown right) provides an airtight seal. Molded runners make for easy alignment and quick installation.



Cumberland's single doors are comprised of lightweight rigid laminate foam panels and include a profiled rubber seal for an airtight fit.



Over time, cords can stretch requiring tension readjustment. Cumberland's easy adjuster makes insuring a reliable door seal a simple task. All brackets are galvanized for durability and long life.

With an insulation value of R-8, the single door tunnel inlet provides excellent energy savings compared to conventional curtain inlets.

Evaporative Cooling Systems

Evaporative cooling systems utilize the natural cooling effect of evaporation to combat seasonal dips in production caused by heat stress.

Made of high quality stainless steel or aluminum, the open top system offers the grower easy access to manage and maintain their evaporative cooling system. This systems' design allows you to see the water jets and easily check water pressure. It also offers access to the spray bar for cleaning.

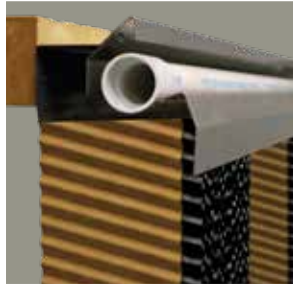

The closed top system is extruded from ultraviolet stabilized PVC for durability and ease of installation. The hinge-open cover and thumbscrews allows accessibility to the spray bar and hold pads firmly in place. The spray bar bracket and water deflector insure pads are uniformly wet.



Cumberland's pre-formed square trough serves as a 3 gallon per lineal foot (44.8 liters per meter) water reservoir. Constructed of corrosion proof, ultra-violet stabilized PVC components, the trough allows unevaporated water to be recirculated back to the holding tank. A perforated tray snaps to the trough to hold pads firmly in place. Injection molded end caps and couplers speed installation.



A roto-molded holding tank offers increased water storage capacity.



Center feed and drain kits are available for longer cooling systems.

OTHER EVAPORATIVE COOLING SYSTEM FEATURES INCLUDE:

- Submersible pump keeps water levels consistent for efficient water delivery
- Automatic float valve for matching water supply with water demand
- Trough support brackets for suspending the system on a sidewall
- Wide selection of cooling pads
- Easy removal of pads for cleaning



JET PUMP FEATURES

- The Jet Pump System provides an external self priming pump.
- Trough mounted float valve eliminates the need for an external tank.
- The Permanent Split Capacitor motor eliminates the start switch and will mount to the wet end of any previous Jet Pump kit.
- Our Jet Pump System is field proven, reliable and a cost effective way to deliver water to Evaporative Cooling Systems.



EVAP COOLING PADS

- Strongest & heaviest pad available
- Produced using the most advanced curing process
- Use the most advanced resin technology
- Superior black diamond edge coating
- Custom sizes from 2' to 6' tall.
- Made in the USA



Cam-Lock system allows toolless pad installation and replacement.



The spray bar bracket and water deflector insure pads are uniformly wet.

RollSeal® Doors

To ensure optimal poultry health, you need to pay careful attention to maintaining the best possible environmental conditions. That means preventing drafts from entering and heat from escaping, making a RollSeal® door the best decision for your operation.

Suitable for any building, new or existing, RollSeal® doors are easy to install and operate and provide years of worry-free environmental control. RollSeal® creates a barrier that keeps the cold out and the warmth in so you know your investment is protected.



RS300 MODEL

- Suitable for all poultry applications
- Sizes up to 14' wide by 14' high
- Custom sizing available so you can find the door that fits your needs



RS400 MODEL

- Ideal for larger applications
- Stronger aluminum channels, drive pipe and larger tension pipes to support longer doors
- Sizes up to 21' wide by 18' high



OPTIONS INCLUDE:

- Additional switches and remote transmitter/receiver options available
- Fabric and window options
- Fabric color options

Patented Triple - Layered Efficiency

Every state-of-the-art RollSeal® door features a tough, tear-resistant patented three-ply fabric of inner and outer layers designed with a durable, long-lasting, hook and loop fastener seal. Each layer works together to provide an energy-efficient double seal, ideal for poultry ventilation applications.

- The upper drive shaft roller lifts and lowers the curtain by the central fabric layer
- By pushing the hook into the loop as the curtain is lowered, two offset lower tension roller bars create the side seal
- Tension rollers hold fabric against the floor for a proper seal
- Patented sealing system provides excellent wind load resistance
- Multilayered, high density, woven-polyethylene fabric has two air pockets that provide good thermal insulation

RollSeal®



Unitized RollSeal® Systems

Cumberland's patented RollSeal® Sidewall System is designed to fit the Komfort Kooler™ Evaporative cooling system with a precision tight fit to limit air infiltration. It utilizes 2 dead air spaces for the best insulating seal and protects cooling pads from inclement weather, dust, UV rays and other harmful environmental elements. Manual and automated drive options are available to best suit your application.

- Superior seal
- 3-layer panel protection
- Pad/System protection from the elements
- 2 dead air spaces to improve insulation value
- Adapts to Komfort Kooler in either the wall mount or direct to concrete versions
- Multiple drive options to best suit your application



Easy Install Easy Operation

Installation couldn't be easier. Simply attach the strong and lightweight aluminum side channels to the head unit, stand the door upright to the frame, bolt the unit in place and you're done. Once installed, your RollSeal® door is simple to maintain and easy to clean.

When you open a RollSeal® door, you'll see how quick and easy it is for anyone to operate the manual chain hoist or the motor drive.

POWER DRIVE AVAILABLE IN...

240v 1ph

208v 3ph

480v 3ph



TIGHT SEAL



MOUNTING BRACKETS

This product may be protected by one or more of the following patents: US5752557, US5960847, US6138739, US6942001, US7828037, AU712128, BR9611473-8, CA2237302, CN325601, EP1338751, IL124347, JP3772992, MX204223, and NO321285



Proven & Dependable™



For more information visit us online at cumberlandpoultry.com

Your Agriculture Company P.O. Box 20; 1004 E. Illinois Street; Assumption, IL. 62510 USA; Ph: 217/226-4401; USA Fax: 800/353-8491; Int'l Fax: 217/226-4420

C-30 1/19 | Copyright © 2019 by AGCO Corporation | Printed in USA | Due to continual improvements, Cumberland reserves the right to change designs and specifications without notice.